

# ODU AMC<sup>®</sup> HIGH-DENSITY RECEPTACLE STYLE 6 ASSEMBLY INSTRUCTION

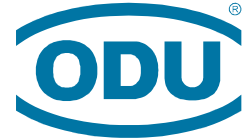

A PERFECT ALLIANCE.

## 1 Assembly sequence

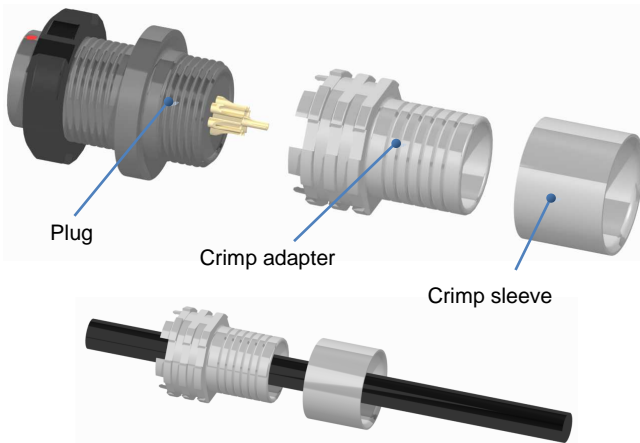

Size	max. cable Ø mm
00 (C)	5.0
0	7.0
1	8.5
1.5 (A)	10.5

Note: Cable with foil shield such as foiled twisted pair-cable (FTP) not suitable for shield termination mentioned below.

1. Slide crimp sleeve and crimp adapter over the cable. The crimp sleeve is not needed if a metal band is used for fastening the shield to the crimp adapter.
2. Strip the cable and conductors<sup>1)</sup>. Fold back the shield and use fastening tape to fasten it temporarily to the cable jacket. Tin-plate this wires if needed.
3. Solder the wires, noting the placement of each wire according to your wiring chart. Clean the solder area with Isopropylalcohol and brush.
4. Screw the crimp adapter on so that it is flush, observing torque values (see page 3). Secure the screw thread with adhesive<sup>2)</sup>.
5. Remove the fastening tape and lay the shield braid on to the crimp adapter. Fasten the shield braid to the crimp adapter by means of crimping or by using a metal band. More information see page 4. Encapsulate the interior of the crimp adapter to secure the soldered points(ODU advise WEVO-2K-casting resin PU552FL).
6. Bend relief: This can be implemented by means of overmolding or by using a shrink tube. More information see page 5.

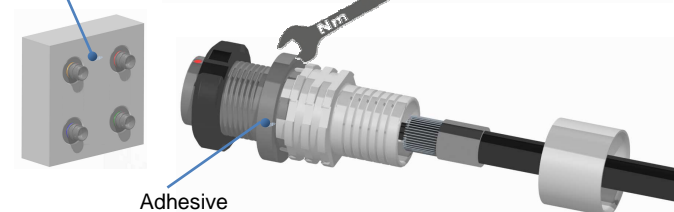
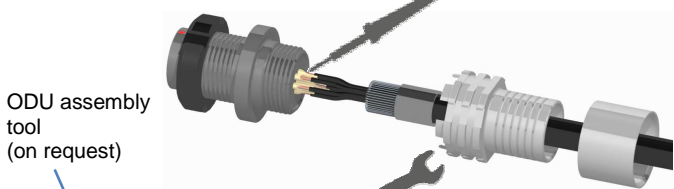
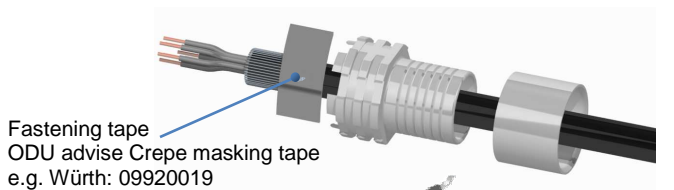

1) Additional information for cable preparation etc. please see page 2 and following  
2) Secure the crimp adapter on housing with adhesive (ODU advise Loctite 2701)

# ODU AMC<sup>®</sup> HIGH-DENSITY RECEPTACLE STYLE 6 ASSEMBLY INSTRUCTION

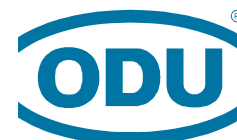

A PERFECT ALLIANCE.

## 2 Cable Preparation

The following table provides recommended guidelines for cable preparation. The according stripping measures have to be checked before assembly!

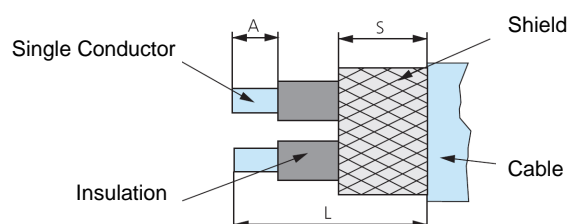

A = Stripping length single conductor  
L = Stripping length cable jacket  
S = Stripping length braided shield

Size	Contact Ø	L	A	S
00	0.3	10	1.5	10
	0.5	8	1.5	8
0	0.3	10	1.5	10
	0.7	10	1.5	10
1	0.3	12	1.5	12
1.5 (A)	0.3	14	1.5	14

All dimensions in mm  
Tolerance: +10 %

Exceptions are noted on special instructions.

### Notes for data-rate-connectors

Before soldering, twist the strands back slightly in the original direction. If a shield is available for the separately pairs of wires (e.g. STP-Cables), wrap it around the pairs as far as possible.

# ODU AMC<sup>®</sup> HIGH-DENSITY RECEPTACLE STYLE 6 ASSEMBLY INSTRUCTION

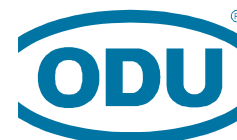

A PERFECT ALLIANCE.

## 3 Assembly Crimp Adapter

Size	Torque Nm	Reference Dimension X mm
00 (C)	0.5	13.0
0	1.0	14.5
1	1.5	18.5
1.5 (A)	2.0	22.5

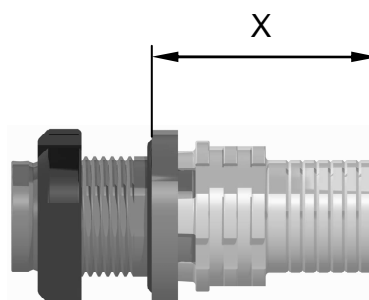

### 3.1 Spann wrench

Size	Part number	Wrench size
00 (C)	598.700.001.001.000	8
0	598.700.001.002.000	10
1	598.700.001.003.000	12
1.5 (A)	598.700.001.005.000	14

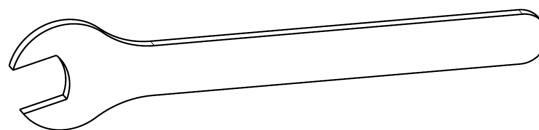

### 3.2 Assembly tool

Size	Part number
00 (C)	713.650.900.000.000
0	700.650.900.000.000
1	701.650.900.000.000
1.5 (A)	715.650.900.000.000

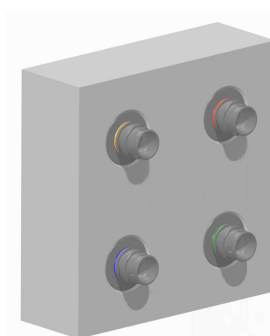

### 3.3 Adhesive

Secure the crimp adapter on housing with adhesive.  
(ODU reference: Loctite 2701)

### 3.4 Potting the interior of the crimp adapter

Encapsulate the interior of the crimp adapter to secure the soldered points with 2K casting resin PU. (ODU reference WEVO-2K-casting resin PU552FL)

# ODU AMC<sup>®</sup> HIGH-DENSITY RECEPTACLE STYLE 6 ASSEMBLY INSTRUCTION

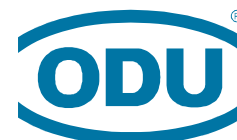

A PERFECT ALLIANCE.

## 4 Assembly crimp sleeve

### 4.1 Crimp tool ODU

Hand-crimptong	
Size	Part number
all	080.000.026.000.000

Crimp dies	
Size	Part number
00 (C)	080.000.026.713.001
0	080.000.026.701.000
1	080.000.026.715.000
1.5 (A)	080.000.026.702.000

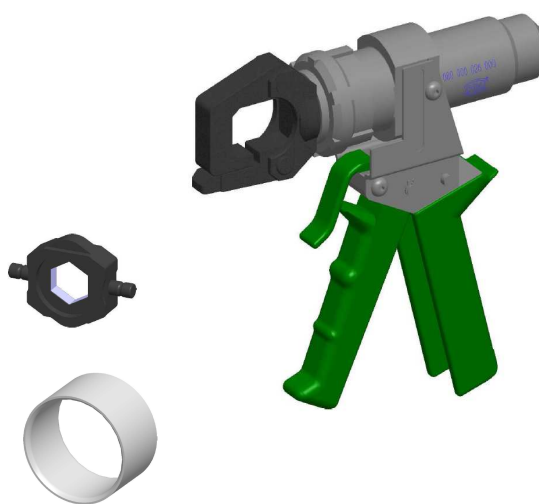

### 4.2 Band-It Bands

Hand-crimptong	
Size	Part number
all	<a href="#">080.000.058.000.000</a>

Tie-Dex Micro Band	
Size	Part number
all	<a href="#">921.000.004.000.248</a>



To connect the shielding with the crimp adapter, using a Tie-Dex Micro Band.

# ODU AMC<sup>®</sup> HIGH-DENSITY RECEPTACLE STYLE 6 ASSEMBLY INSTRUCTION

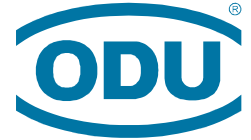

A PERFECT ALLIANCE.

## 5 Cable interface

ODU provides three different solutions for the cable interface. According to the requirements the customer can choose between overmolding, heat shrinkable molded parts and heat shrinkable tubing.

### 5.1 ODU overmolding (recommended series solution)

ODU provides complete solutions with straight overmoldings on request.



Example image: Break-Away Plug and In-Line Receptacle (size 00)

### 5.2 Heat shrinkable molded parts (samples, pre-series)

Size	Part number		Min. cable Ø in mm
	ODU	Supplier	
00 (C)	921.000.010.008.103	202K111-25 (Tyco)	3.0
0-1.5 (A)	921.000.010.008.084	401-52880 (Hellermann)	6.0

To a better adhesion of the heatshrink boots on housing and cable, ODU recommends to work with an epoxyd-adhesion (e. g. Hellermann V9500, Raychem S1125).



Example image: Break-Away Plug and In-Line Receptacle (size 1)

# ODU AMC<sup>®</sup> HIGH-DENSITY RECEPTACLE STYLE 6 ASSEMBLY INSTRUCTION

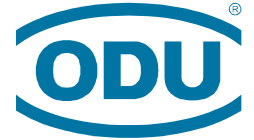

A PERFECT ALLIANCE.

## 5.3 Heat shrinkable tubing (samples, pre-series)

Size	Part Number		Min. cable Ø in mm
	ODU	Tyco	
00 (C)	921.000.010.008.093	ATUM-12/3	3.0
0	921.000.010.008.093	ATUM-12/3	3.0
1	921.000.010.008.077	ATUM-16/4	4.0
1.5 (A)	921.000.010.008.077	ATUM-16/4	4.0

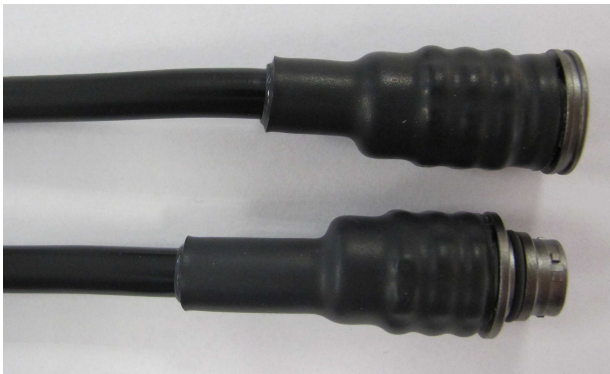

Example image: Break-Away Plug and In-Line Receptacle (size 1)